

悬臂组件50-65系列

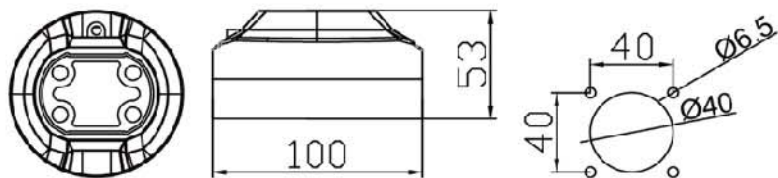

品名: 箱体连接器
 订货号: 50-65-2090
 重量: 0.6kg
 材料: 压铸铝合金
 可旋转320°



品名: 转角
 订货号: 50-65-210
 重量: 0.4kg
 材料: 压铸铝合金

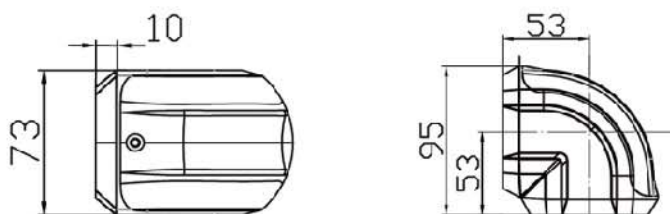

品名: 顶座
 订货号: 50-65-220
 重量: 0.9kg
 材料: 压铸铝合金
 可旋转320°

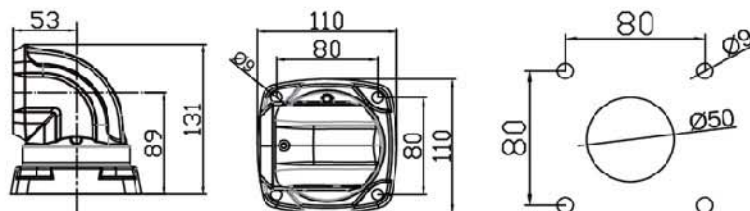

品名: 中间连接器
 订货号: 50-65-230
 重量: 1.0kg
 材料: 压铸铝合金
 可旋转320°

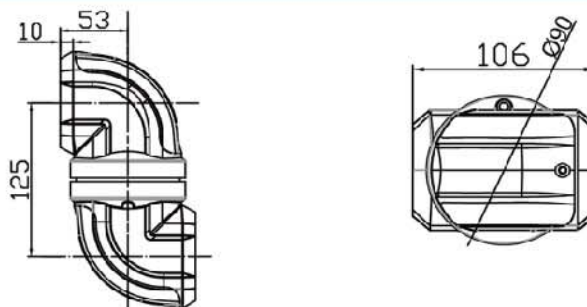

悬臂组件50-65系列



品名: 固定底座
 订货号: 50-65-240
 重量: 0.4kg
 材料: 压铸铝合金

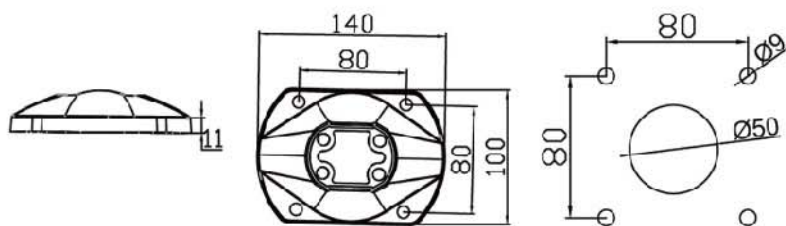

品名: 90° 箱体连接器
 订货号: 50-65-250
 重量: 0.8kg
 材料: 压铸铝合金
 可旋转320°

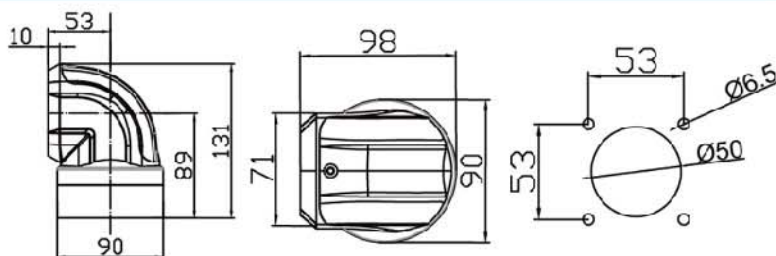

品名: 水平墙座
 订货号: 50-65-260
 重量: 1.3kg
 材料: 压铸铝合金
 可旋转320°

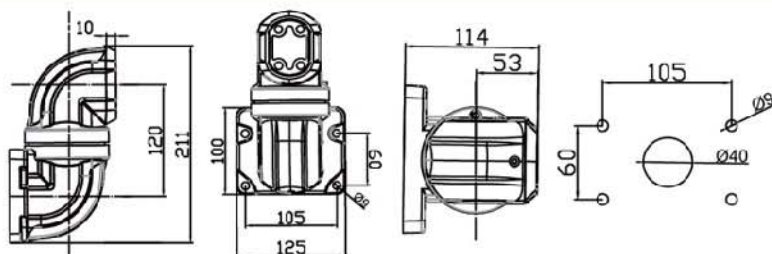

品名: 垂直墙座
 订货号: 50-65-270
 重量: 1.2kg
 材料: 压铸铝合金
 可旋转320°

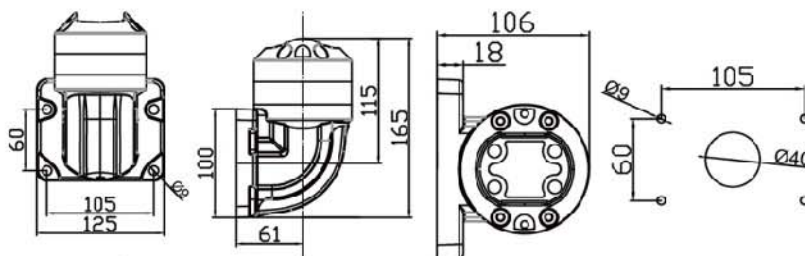

悬臂组件50-65系列



品名:底座
 订货号:50-65-280
 重量:0.9kg
 材料:压铸铝合金
 可旋转320°

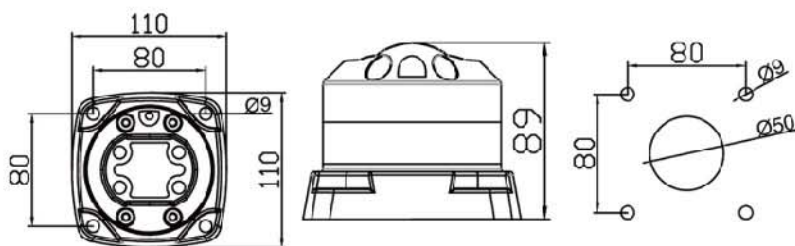

品名:旋转转角
 订货号:50-65-290
 重量:0.9kg
 材料:压铸铝合金
 可旋转320°

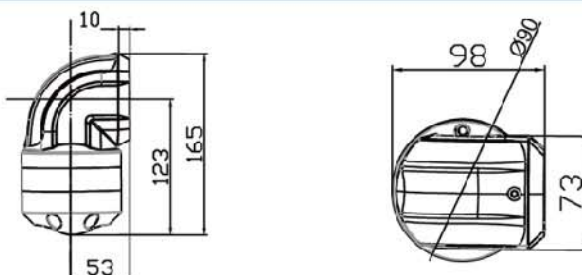

品名:可旋转箱底座
 订货号:50-65-4900
 重量:0.8kg
 材料:压铸铝合金
 可旋转320°

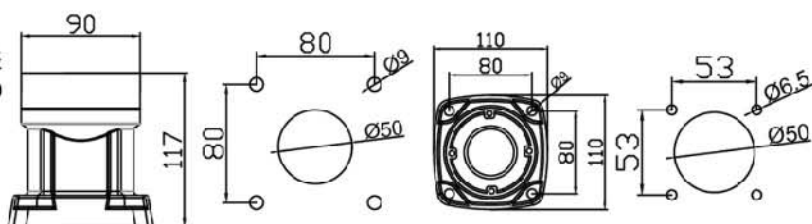

品名:连接管
 订货号:50-65
 重量:2.2kg/m
 材料:铝合金

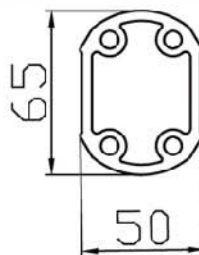

品名:窄边箱体连接器
 订货号:50-65-2091
 重量:0.5kg
 材料:压铸铝合金

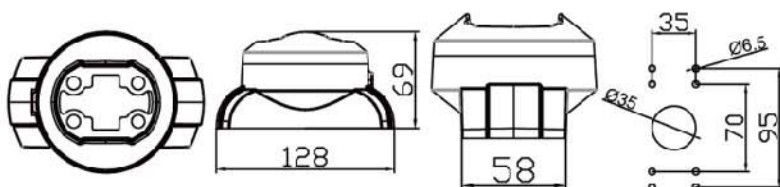

悬臂组件60-95系列



品名:箱体连接器
 订货号:60-95-3090
 重量:0.9kg
 材料:压铸铝合金
 可旋转320°

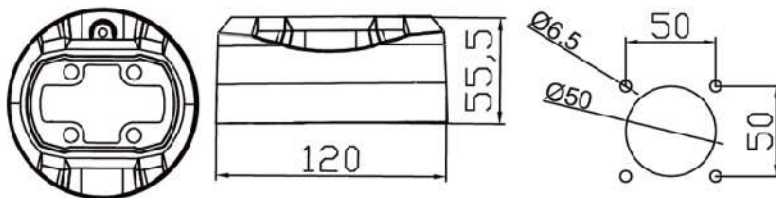

品名:转角
 订货号:60-95-310
 重量:0.7kg
 材料:压铸铝合金

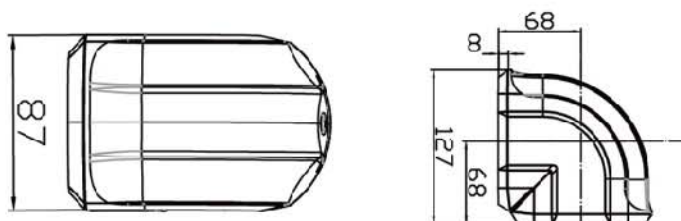

品名:顶座
 订货号:60-95-320
 重量:1.8kg
 材料:压铸铝合金
 可旋转320°

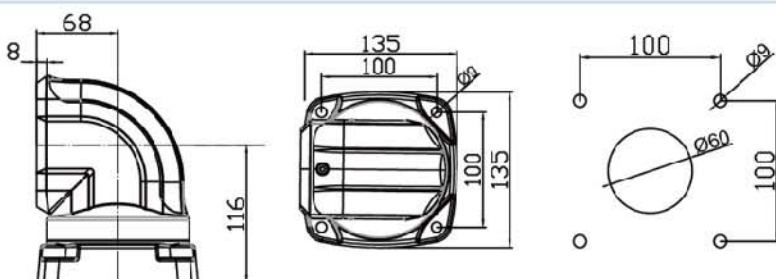

品名:中间连接器
 订货号:60-95-330
 重量:2.2kg
 材料:压铸铝合金
 可旋转320°

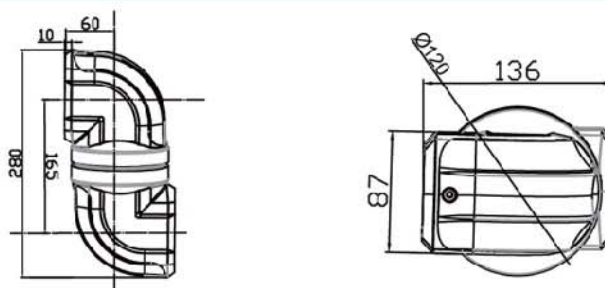

悬臂组件60-95系列



品名:固定底座
 订货号:60-95-340
 重量:0.6kg
 材料:压铸铝合金

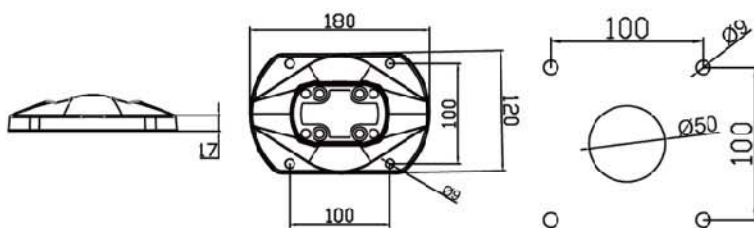

品名:90° 箱体连接器
 订货号:60-95-350
 重量:1.5kg
 材料:压铸铝合金
 可旋转320°

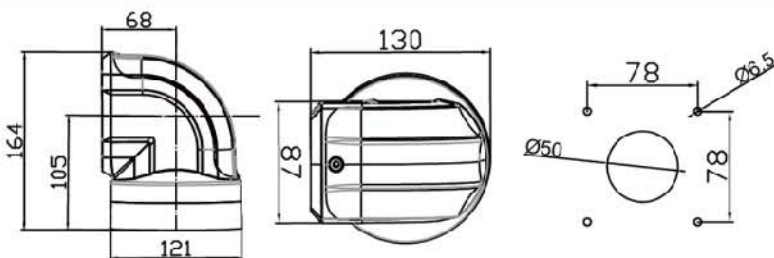

品名:水平墙座
 订货号:60-95-360
 重量:2.9kg
 材料:压铸铝合金
 可旋转320°

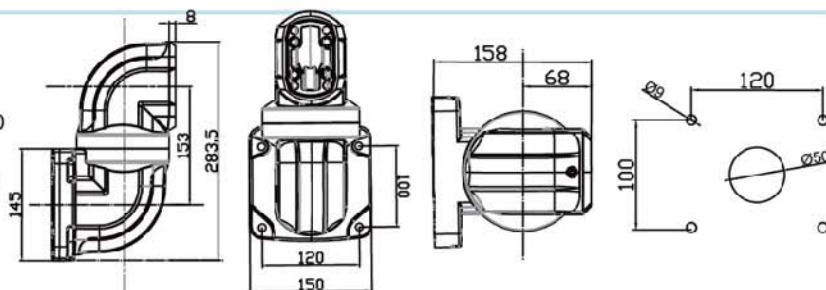

品名:垂直墙座
 订货号:60-95-370
 重量:2.7kg
 材料:压铸铝合金
 可旋转320°

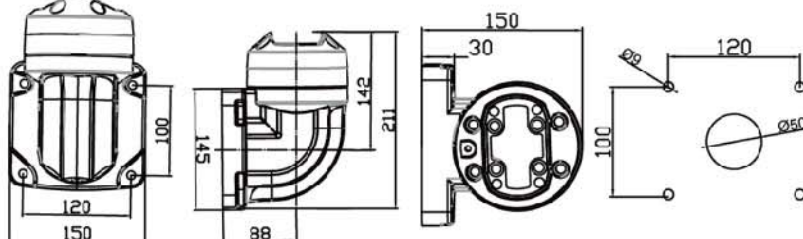

悬臂组件60-95系列



品名: 底座
 订货号: 60-95-380
 重量: 1.6kg
 材料: 压铸铝合金
 可旋转320°

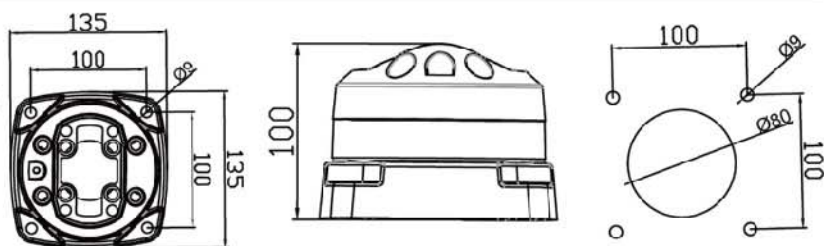

品名: 旋转转角
 订货号: 60-95-390
 重量: 1.9kg
 材料: 压铸铝合金
 可旋转320°

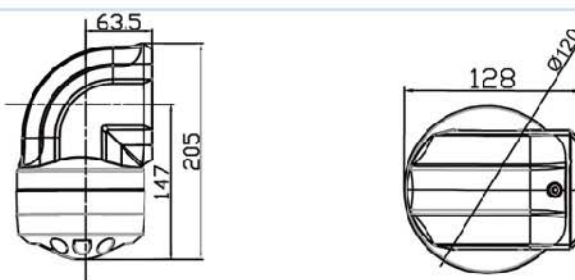

品名: 连接管
 订货号: 60-95
 重量: 3.2kg/m
 材料: 铝合金

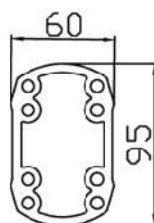

品名: 窄边箱体连接器
 订货号: 60-95-3091
 重量: 1.0kg
 材料: 压铸铝合金
 可旋转320°

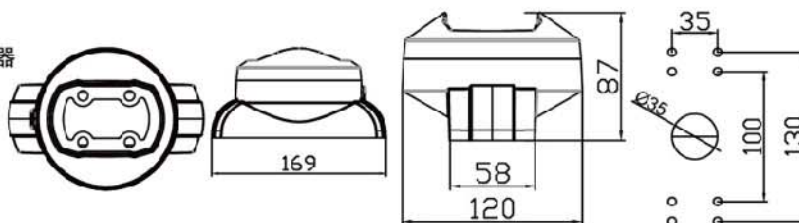

品名: 中转小
 订货号: 60-95转50-65
 重量: 0.3kg
 材料: 压铸铝合金

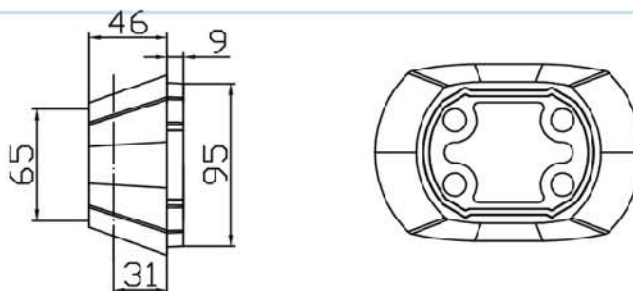

悬臂组件75-110系列



品名:箱体连接器
 订货号:75-110-5090
 重量:1.0kg
 材料:压铸铝合金
 可旋转320°

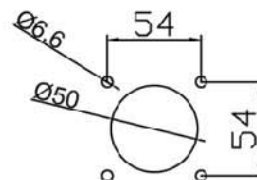
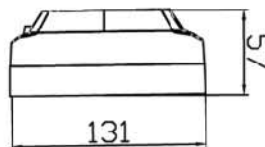
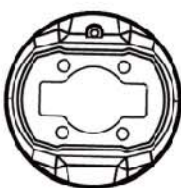

品名:转角
 订货号:75-110-510
 重量:1.1kg
 材料:压铸铝合金

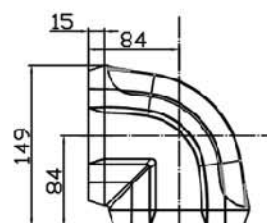
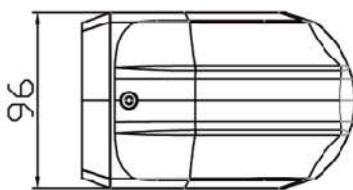

品名:顶座
 订货号:75-110-520
 重量:4.8kg
 材料:压铸铝合金
 可旋转320°

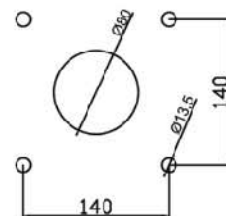
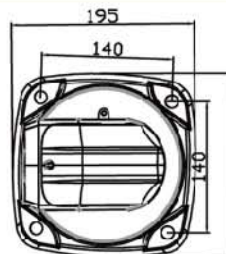
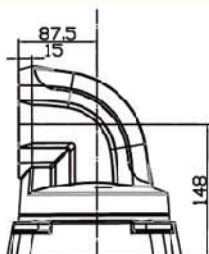

品名:中间连接器
 订货号:75-110-530
 重量:4.5kg
 材料:压铸铝合金
 可旋转320°

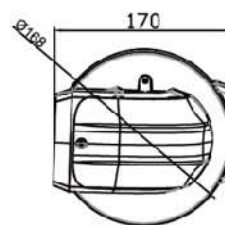
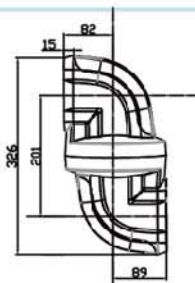

悬臂组件75-110系列



品名:固定底座
 订货号:75-110-540
 重量:0.9kg
 材料:压铸铝合金

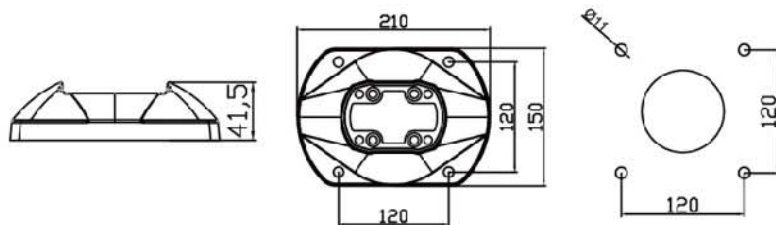

品名:90°箱体连接器
 订货号:75-110-550
 重量:1.8kg
 材料:压铸铝合金
 可旋转320°

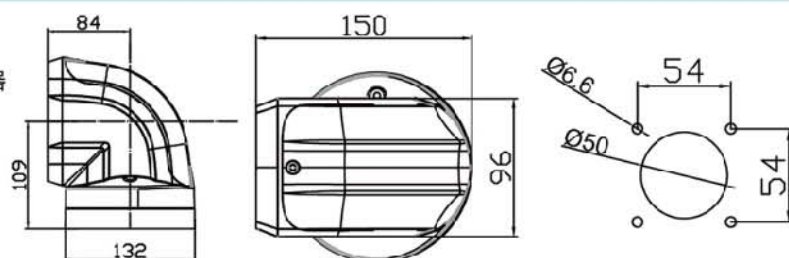

品名:水平墙座
 订货号:75-110-560
 重量:5.4kg
 材料:压铸铝合金
 可旋转320°

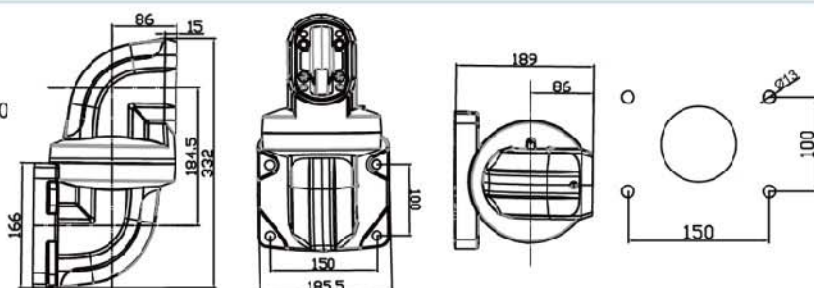

品名:垂直墙座
 订货号:75-110-570
 重量:5.1kg
 材料:压铸铝合金
 可旋转320°

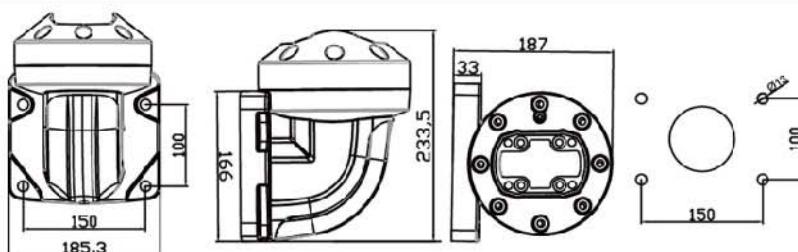

悬臂组件75-110系列



品名:底座
 订货号:75-110-580
 重量:4.4kg
 材料:压铸铝合金
 可旋转320°

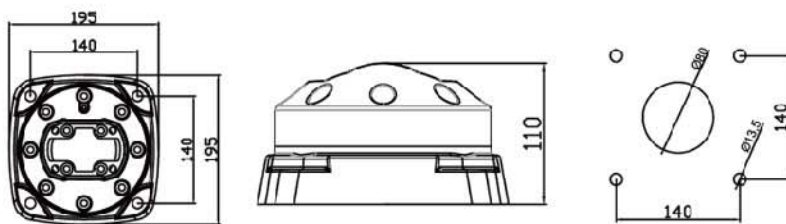

品名:旋转转角
 订货号:75-110-590
 重量:4.3kg
 材料:压铸铝合金
 可旋转320°

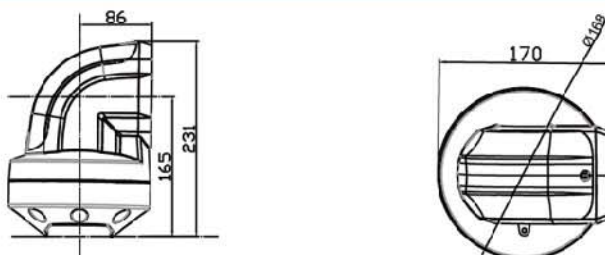

品名:连接管
 订货号:75-110
 重量:6.2kg/m
 材料:铝合金

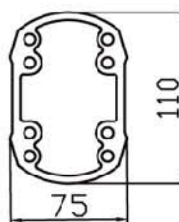

品名:大转小
 订货号:75-110转50-65
 重量:0.4kg
 材料:压铸铝合金

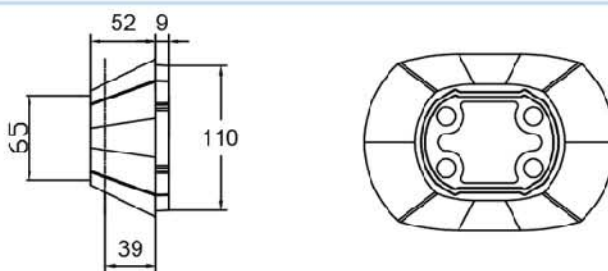

品名:大转中
 订货号:75-110转60-95
 重量:0.5kg
 材料:压铸铝合金

